



make your  
**RESTROOM**  
the BEST ROOM

your  
**INDUSTRY**  
LEADER

Hiny Hiders Partitions – Color: Grey, Texture: Orange Peel  
Configuration: Floor Mounted Overhead Braced, Height: 55” Standard Panels & Doors  
Vanities, Urinal Screens/Panelaster, Tufftec Benches – Color: Grey  
Tufftec Lockers – Color: Blueberry

With over **30 years of experience**, Scranton Products is the industry leader in plastic bathroom partitions and lockers. Constructed from **premium, American-made solid plastic**, our products resist impacts, scratches, corrosion, graffiti and mildew.

When you purchase Scranton Products, you are **investing in peace of mind**. With unmatched durability and an array of designer colors and textures, Scranton Products installs confidence in every product.

**INNOVATIVE SOLUTIONS FOR A BETTER FUTURE**

# FAMILY OF PRODUCTS



**ARIA PARTITIONS.**  
EXPECT MORE



**ECLIPSE PARTITIONS.**  
PRIVACY BY DESIGN



**HINY HIDERS®**  
STYLE THAT LASTS AND LASTS



**TUFFTEC LOCKERS.**  
LOCKER SOLUTIONS FOR EVERY PLACE & PURPOSE



**DURALIFE LOCKERS™**  
BUILT FOR THE LONG HALL

## VANITIES



## BENCHES



## URINAL SCREENS



## SHOWER DIVIDERS



## DRESSING COMPARTMENTS



## CUBBIES



## PRIVACY & HEALTH BARRIERS



[www.scrantonproducts.com](http://www.scrantonproducts.com)

why

# PERFORMANCE PLASTICS

Commercial bathroom partitions are placed in harsh, high traffic environments that tend to be damp, making the materials susceptible to mold, mildew and rust. It is also common to encounter graffiti and vandalism in these public spaces.

**It is important to invest in a worry-free product that will save you time and money.**

Solid plastic partitions are built to last, down to every detail. Graffiti can be easily wiped clean with a common non-abrasive cleaner, and since Scranton Products performance plastic is formulated with a solid color throughout, scratches are difficult to see. Compared to other traditional material types, performance plastic has a greater resistance to impacts providing you with a low maintenance restroom that will look great for years.



Aria Partitions – Color: White, Texture: Orange Peel  
Door Engraving: Exclusive 5400, Side Panel Engraving: Diamond, Height: 96"

Patent Pending

## NO PAINTING

Scranton Products partitions are solid color throughout and will never require painting.

## EASY GRAFFITI REMOVAL

Graffiti can be easily wiped clean with a common, non-abrasive cleaner.

## CLEANER, HEALTHIER RESTROOMS

Impermeable to moisture, solid plastic's non-porous surface does not support the growth of mold and mildew and will never rust.

## NATURALLY GERM & VIRAL RESISTANT

Scranton Products partitions showed a significant decrease in Influenza, Human rhinovirus and Human Coronavirus viral activity within 24hrs of exposure\*. Scranton Products partitions are naturally resistant to common bacteria including MRSA and a.baumannii which can cause Pneumonia\*. According to testing, Scranton Products partitions are highly effective at reducing MRSA and a.baumannii. Testing has shown that after 24 hours, a significant amount of MRSA died off the surface of solid plastic without the use of cleaning solutions or antimicrobial additives.

ISO 21702 Testing done by SITU for Influenza A virus (H1N1), Human rhinovirus 37 (Strain 151-1) and Human Coronavirus (229E).  
ISO 22196 Testing done by SITU

expect  
**MORE**

Aria Partitions  
Color/Texture: White & Black, Orange Peel, Trim: Standard, Door Style: Traditional 1000

Aria Partitions will provide **increased privacy** and design allowing you to **EXPECT MORE** when choosing a commercial restroom partition.



**ARIA  
PARTITIONS.**

**FEATURES**

- Increased privacy design
- Customizable
- Unsurpassed durability
- Sustainable
- Cleaner, healthier restrooms

US D887,021 S

# expect more out of **RESTROOM** DESIGN



Aria Partitions  
Color/Texture: Mahogany, Orange Peel, Trim: Fluted, Door Style: Traditional 2600



ARIA PARTITIONS

Bring your restroom experience to life. Aria Partitions offers **millions of design combinations** to choose from and will provide you with an **increased privacy experience**.

US D887,021 S

**DOOR DESIGN OPTIONS**  
17 unique door designs ranging from Classic to Exclusive.

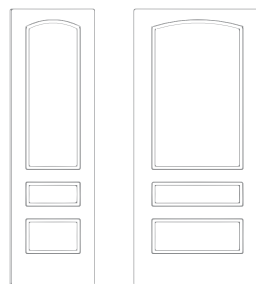

**SHIPLAP EDGE**  
Creates an overlap, minimizing vertical sight lines for increased privacy.

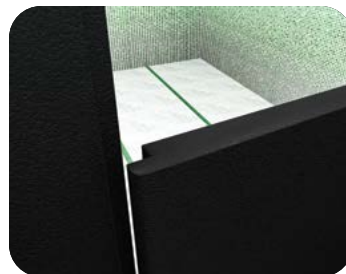

**FULL HEIGHT COMPARTMENT**  
Optional full height compartment to provide the increased privacy.

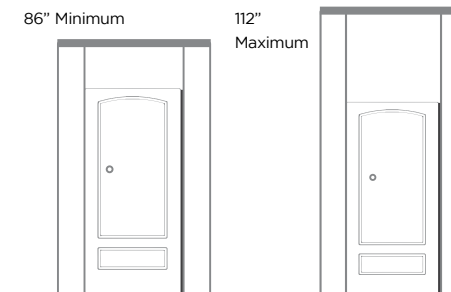

**PANEL DESIGN OPTIONS**  
7 panel designs to fully customize your restroom.



# DOOR & PANEL DESIGNS

Patent Pending

US D887,021 S

## TRADITIONAL DOOR SERIES



## MODERN DOOR COLLECTION

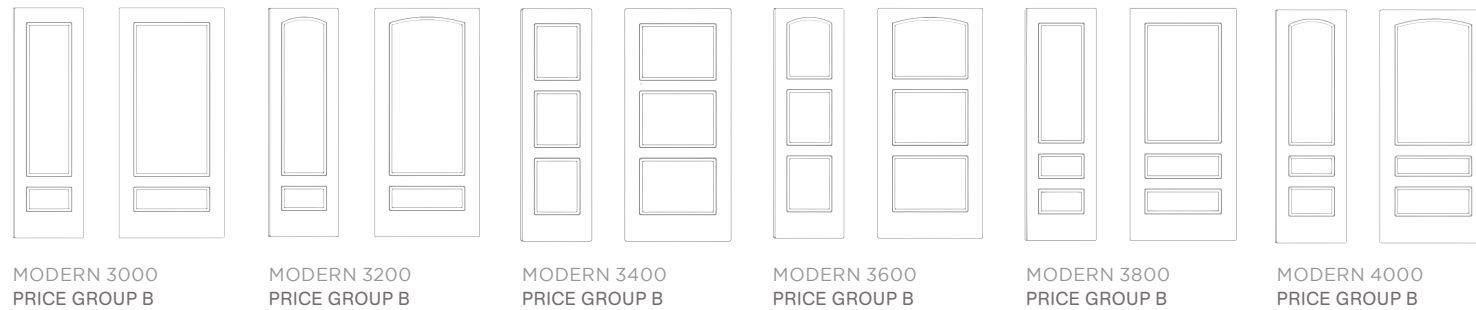

## EXCLUSIVE DOOR COLLECTION

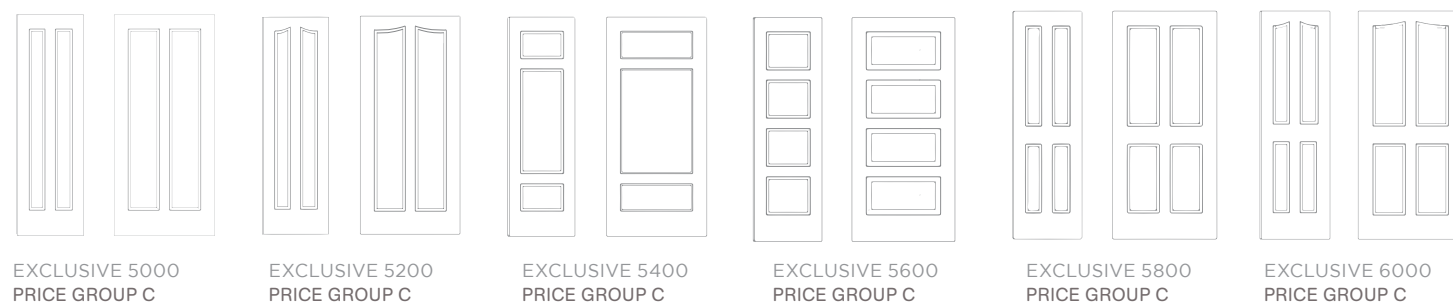

\*Illustrations represent 24" and

## SIDE PANEL OPTIONS

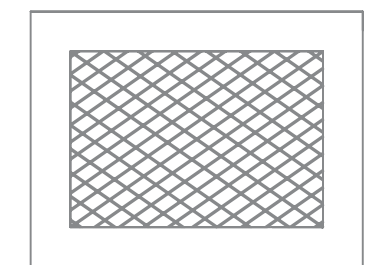
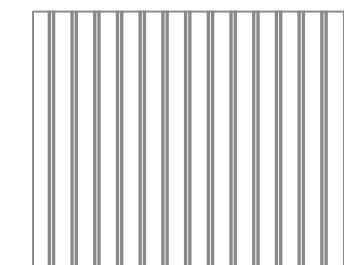
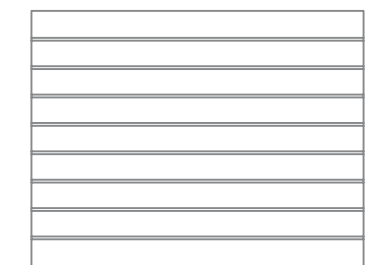
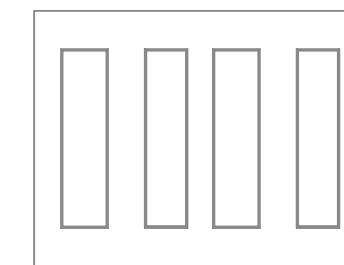
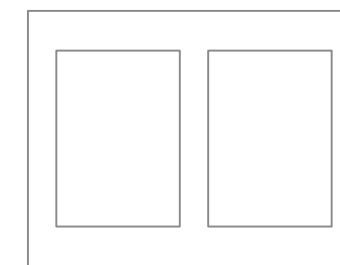

# COLOR, TEXTURE & DESIGN OPTIONS



US D887,021 S

## COLORS TESTED IN ACCORDANCE WITH NFPA 286

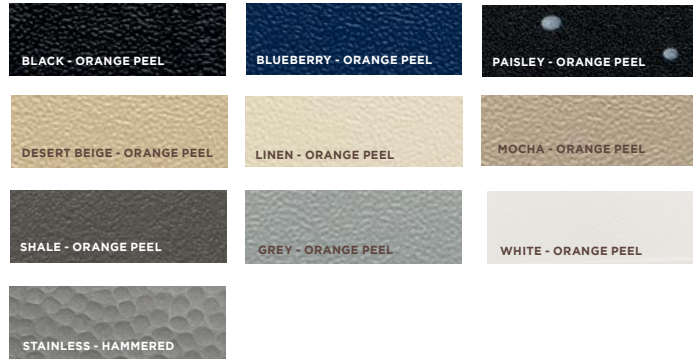

## COLORS TESTED TO MEET ASTM E84, CLASS B

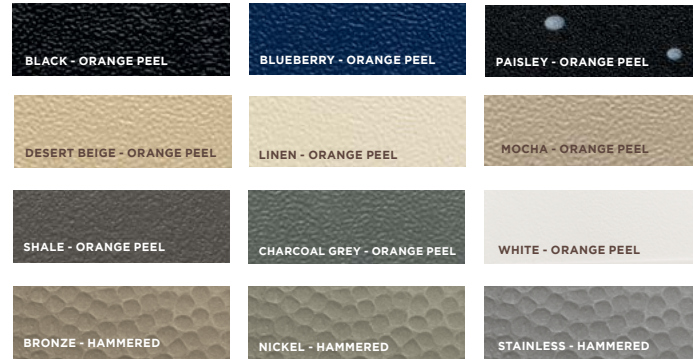

## STANDARD COLOR COLLECTION\*

### TRADITIONAL COLOR COLLECTION

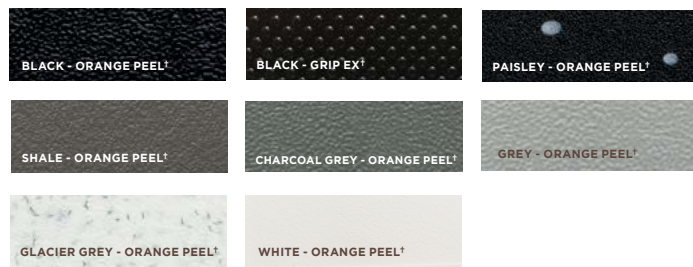

### BOLD COLOR COLLECTION

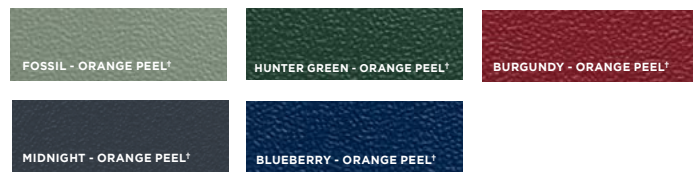

### WARM TONE COLOR COLLECTION

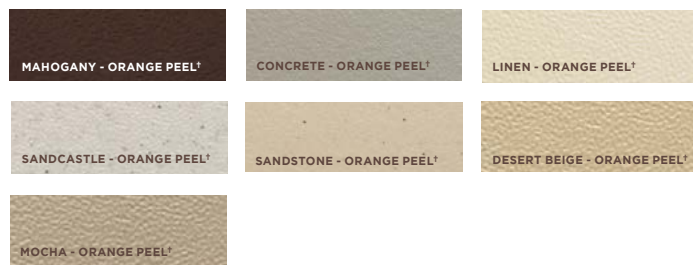

### METALLIC COLOR COLLECTION

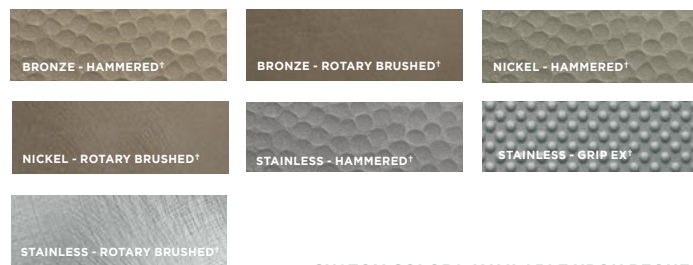

### CUSTOM COLORS AVAILABLE UPON REQUEST

Color matching is limited by printing process. Actual samples are available and recommended prior to color selections.

\*Minimum order requirements, lead-times & upcharges may all apply.

## TRIM COLOR

Sold in 96" lengths except as noted.



Check on Fire Rated Trim options with your Product Specialist \*84" Lengths

H = Hammered Texture  
RB = Rotary Brushed Texture  
All others in Orange Peel texture

## TRIM CHOICES

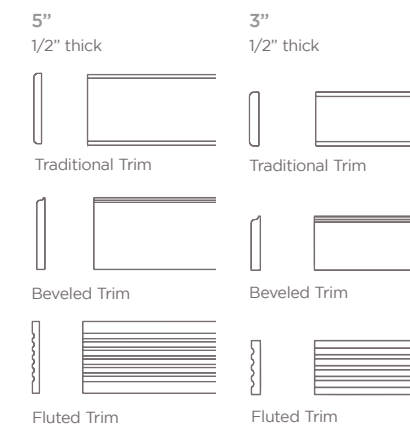

### ADDITIONAL TRIM OPTIONS

- Interior Side Panel Top Trim (ADDITIONAL CHARGES APPLY) (NO PHOTO SHOWN)
- Notched Top Trim\*\* (ADDITIONAL CHARGES APPLY)

\*\*NOTE: EXTERIOR TRIM ONLY FOR TOP TRIM AND BASE MOLDING

### STANDARD TRIM INCLUDES:

(EXTERIOR TRIM ONLY FOR TOP)



### ENHANCED TRIM INCLUDES:

(EXTERIOR TRIM ONLY FOR TOP; EXTERIOR FRONT BASE MOLDING AND CHAIR RAIL THROUGHOUT)

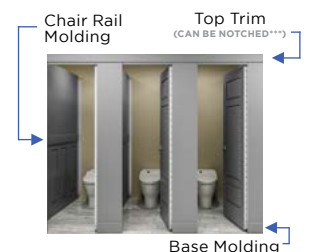

Standard Trim Package (top trim) included. Enhanced Trim Package available (chair rail, base molding). Additional trim can be quoted as an additional charge.

## HARDWARE

### BRACKETS

U Bracket Aluminum

Single Ear Aluminum

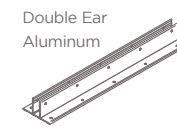

Mending Plate & Mending Plate Cover Options\* (Transom Panel Connections) Stainless Steel

\*Ask your Scranton Products representative about color options.

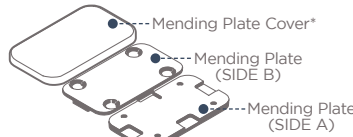

Angle Bracket (Pilaster Attachment) Aluminum

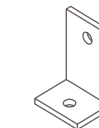

### HINGES

Edge Mounted Continuous Stainless Steel Hinge



### DOOR ACCESSORIES

Coat Hook Bumper



Wall Stop



### HEADRAIL

Aluminum

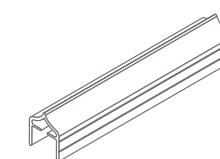

### LATCH

Privacy Indicator Latch

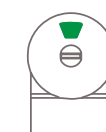

### HEIGHT OPTIONS

86" Minimum

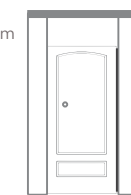

112"

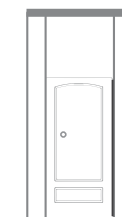

Modular Panels \*Panel stacking with hidden dowels are provided on all configurations.

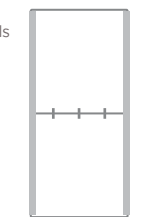



# privacy by **DESIGN**

Eclipse Partitions – Color: White, Texture: Orange Peel  
Configuration: Floor Mounted Overhead Braced, Height: 62" High Panels & Doors

**Eclipse Partitions** are the future of restroom partitions that offer both **innovative design aesthetics** and **durable performance**.

The clean lines of this system provide a **contemporary, high-end look** to any bathroom décor.



**ECLIPSE**  
PARTITIONS.

## FEATURES

- High-end, sleek design
- Innovative hinge & post design structure
- Contemporary anti-grip head rail
- Durable solid performance plastic material

Patent Pending

# next GENERATION OF PARTITIONS



Eclipse Partitions - Color: Sandstone, Texture: Orange Peel  
Configuration: Floor Mounted Overhead Braced, Height: 62" High Panels & Doors



ECLIPSE PARTITIONS  
Combining **innovative aesthetics** with **durable performance**, Eclipse Partitions' contemporary, high-end look and extensive color and texture collections are sure to **enhance your facility décor**.

Patent Pending

**INNOVATIVE HINGE**  
The edge-mounted continuous stainless steel hinge provides a sleek aesthetic to your restroom design.

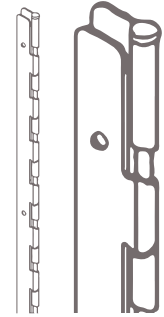

**SHIPLAP EDGE**  
Creates an overlap, minimizing vertical sight lines for increased privacy.

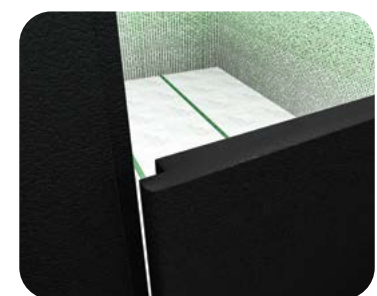

Example of shiplap

**CLEAN EXTERIOR AESTHETICS**  
Designed with minimal exterior hardware visible on the outside of the stalls.



**HEIGHT OPTIONS**  
55" standard, \*62" high, and \*72" extra high doors and panels.

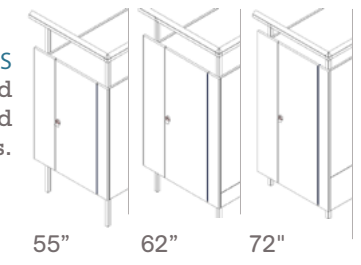

\*Modular panel may be required if stall depth is greater than 55".

# COLOR, TEXTURE & DESIGN OPTIONS



Patent Pending

## COLORS TESTED IN ACCORDANCE WITH NFPA 286

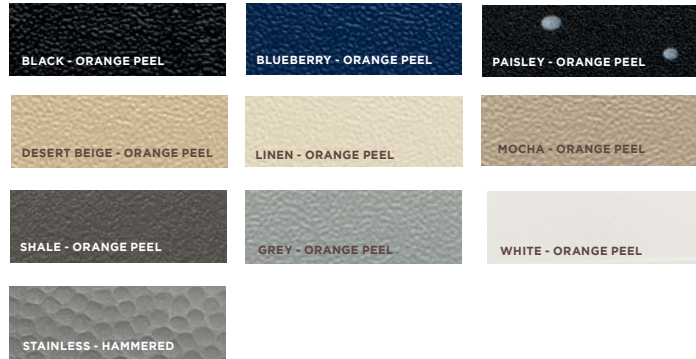

## COLORS TESTED TO MEET ASTM E84, CLASS B

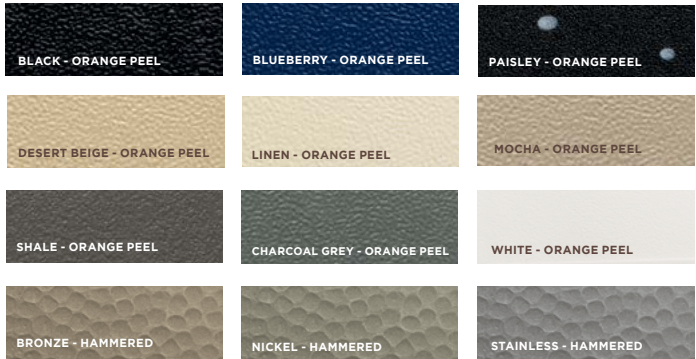

## DESIGN OPTIONS

BRACKETS  
Single Ear Bracket

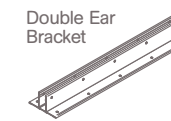
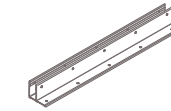

HINGES  
Edge-Mounted  
Stainless Steel  
Continuous Hinge



STANCHION

Stanchion Cap



Stanchion



Corner Cap



Stanchion Support



HEAD RAIL  
Aluminum

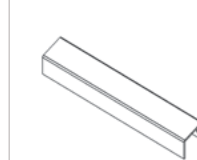

LATCH  
Occupancy Indicator

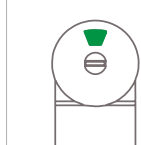

## STANDARD COLOR COLLECTION\*

### TRADITIONAL COLOR COLLECTION

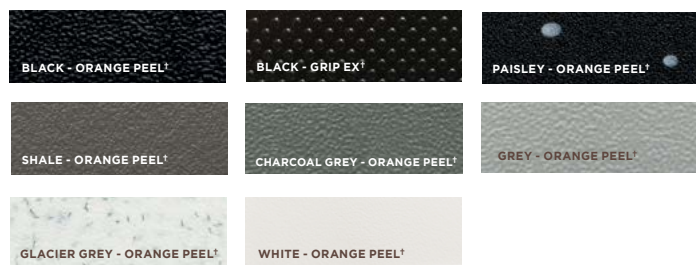

### WARM TONE COLOR COLLECTION

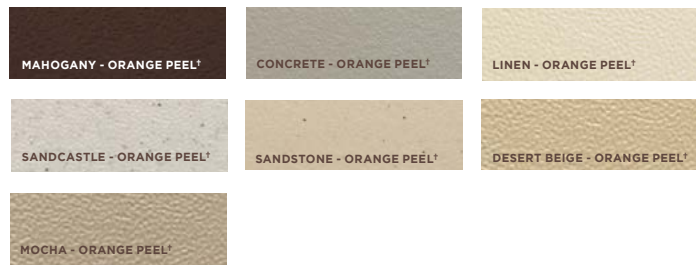

### BOLD COLOR COLLECTION

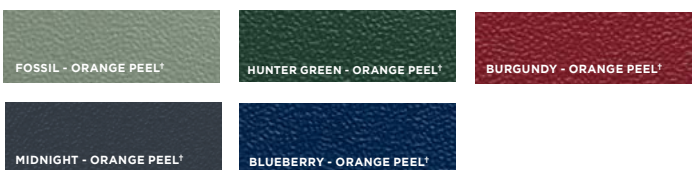

### METALLIC COLOR COLLECTION

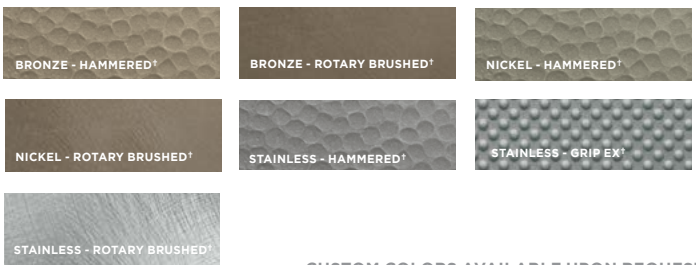

### CUSTOM COLORS AVAILABLE UPON REQUEST

Color matching is limited by printing process. Actual samples are available and recommended prior to color selections.

\*Minimum order requirements, lead-times & upcharges may all apply.

## HEIGHT OPTIONS

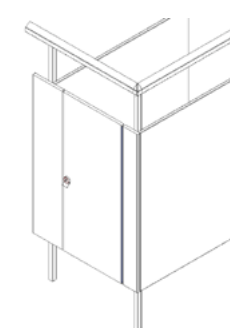

55" Standard

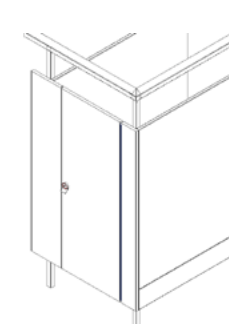

62" High\*

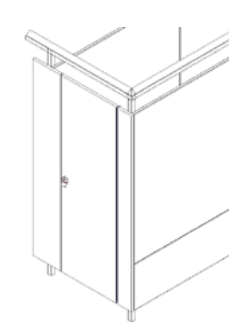

72" Extra High\*

\*Modular panel may be required if stall depth is greater than 55".

Modular Panels

\*Panel stacking with hidden dowels are provided on all configurations



## CONFIGURATION OPTIONS

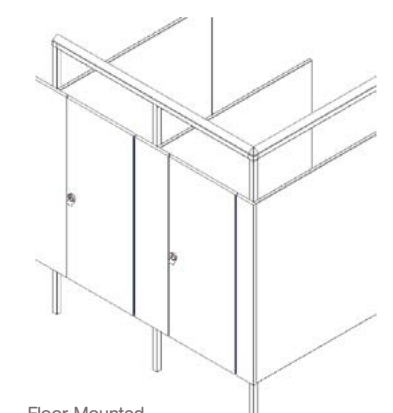

Floor Mounted Overhead Braced

# style that **LASTS** AND LASTS

Hiny Hiders Partitions - Color: Black, Texture: Orange Peel, Hardware: Continuous Aluminum Hinge & Strike  
Configuration: Floor Mounted Overhead Braced, Height 72" Extra High Panels & Doors

With **tough construction** and **rugged good looks**, Hiny Hiders Partitions offer durability that will save customers time, hassle, and maintenance costs. Hiny Hiders Partitions offer **superior value** that simply can't be beat by the competition.



## FEATURES

- Durable solid performance plastic material
- Solid classic construction
- Multiple hardware options
- Numerous design configurations
- High privacy options

Hiny Hiders Partitions – Color: Black, Texture: Orange Peel, Configuration: Floor Mounted Overhead Braced, Height: 55”, Door Engraving: Traditional 2600

# SIGNATURE SERIES

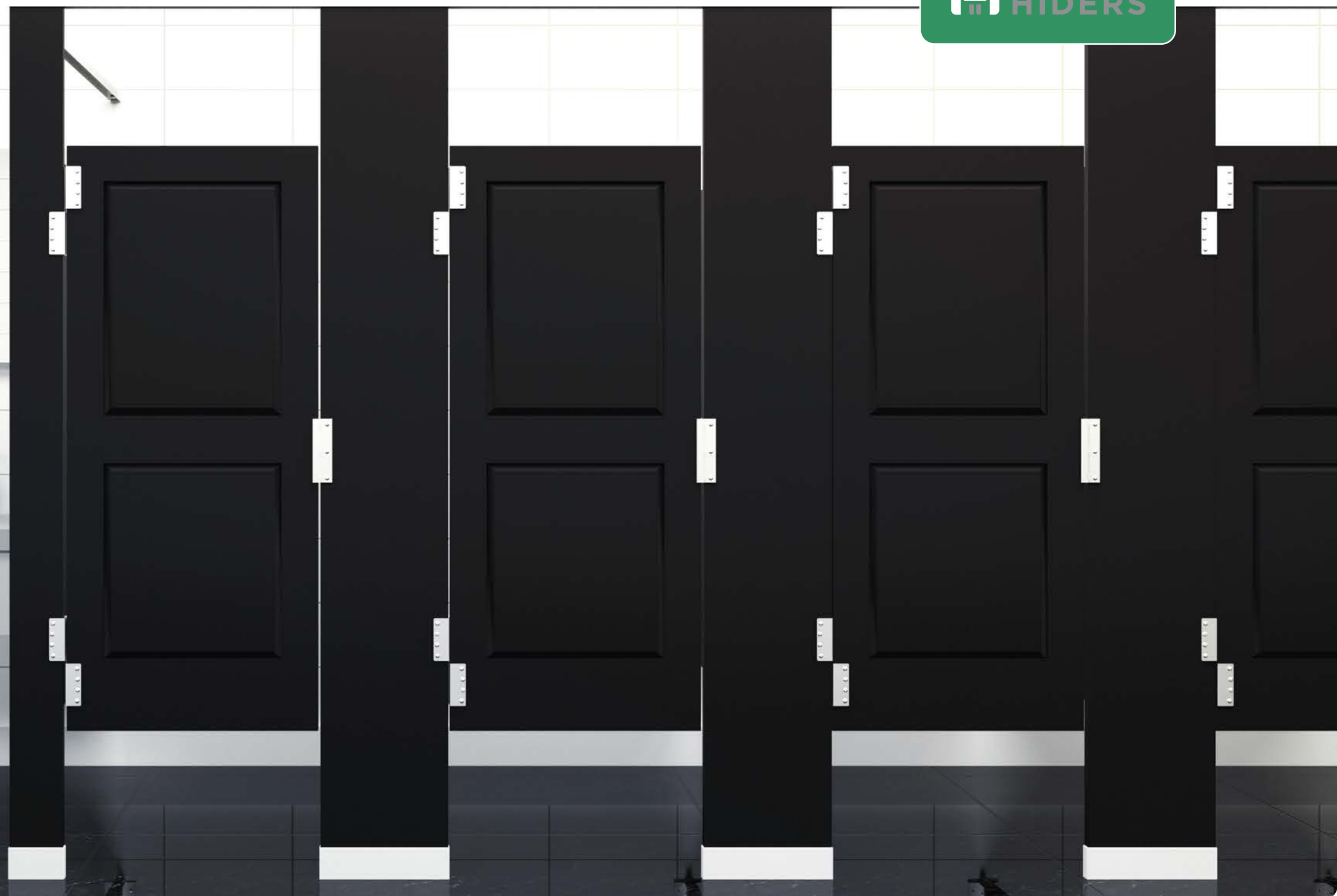

### FLOOR MOUNTED OVERHEAD BRACED

This classic style provides the most economical solution for high traffic areas where durability is a top priority. Easy installation in new construction or existing buildings makes this a versatile style option.

### SIGNATURE DOOR & SIDE PANEL ENGRAVING

Scranton Products introduces a signature door collection to our Hiny Hiders Partitions. The same tough construction combined with 6 new door designs to enhance your traditional commercial restroom design.

### SIGNATURE ENGRAVING OPTIONS



# PRIVACY & HEALTH BARRIERS

Privacy & Health Barriers – Color: Bronze, Texture: Hammered



## WHERE PRIVACY MEETS EFFICIENCY

Scranton Products now offers larger barriers that can be used for increased protection and privacy between urinals, sinks and hand dryers. Maximize facility capacity while decreasing occupants' time in the restrooms and supporting safer social distancing. Provide safer protection with a naturally germ-resistant solution and avoid lines inside and outside the restroom or washroom.

## BARRIER OPTIONS



SINK DIVIDERS



URINAL DIVIDERS



HAND DRYER DIVIDERS

## HARDWARE OPTIONS

### SHOES

Plastic      Stainless Steel

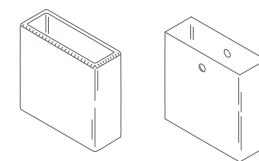

### BRACKETS

**Urinal & Hand Dryers Dividers:**  
**Single/Double Ear Brackets**  
 Plastic: 54"  
 Aluminum: 68", 71", 76"  
 Stainless Steel: 54", 71"

Double Ear

Single Ear

U Bracket

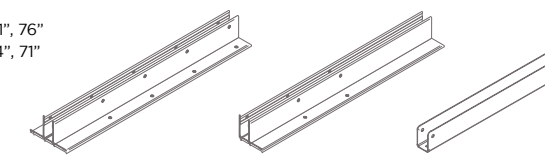

**Sink Divider:**  
**U Bracket**  
 Plastic: 29"  
 Aluminum: 29"

# SUPERIOR STRENGTH & LOW MAINTENANCE

Hiny Hiders Partitions – Color: Mahogany, Texture: Orange Peel, Hardware: Stealth Integral Hinge  
Configuration: Floor To Ceiling, Height: 55" Standard Panels & Doors



#### FLOOR MOUNTED OVERHEAD BRACED

This classic style provides the most economical solution for high traffic areas, where durability is a top priority. Easy installation in new construction or existing buildings makes this a versatile style option.

#### FLOOR TO CEILING

This style provides an extra measure of stability in restrooms. Maximum rigidity is achieved when structural supports are present in the ceiling.

120" Maximum Ceiling Height.

#### CEILING HUNG

This style offers an area free from obstruction to allow for fast and easy maintenance. The system requires structural supports in the ceiling for maximum rigidity.

120" Maximum Ceiling Height.

#### STEALTH INTEGRAL HINGE

This hinge is a perfect hardware match for a space seeking a minimal design aesthetic.

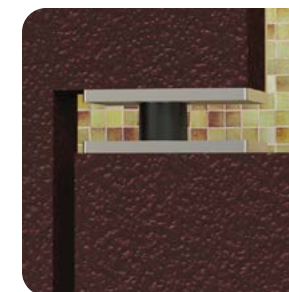

#### ORANGE PEEL TEXTURE

This texture pairs great with any color choice and will compliment any environment.

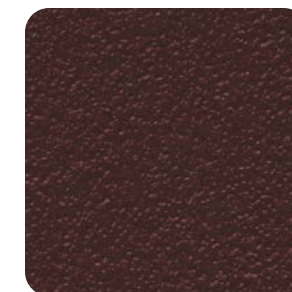

# COLOR, TEXTURE & DESIGN OPTIONS

## COLORS TESTED IN ACCORDANCE WITH NFPA 286

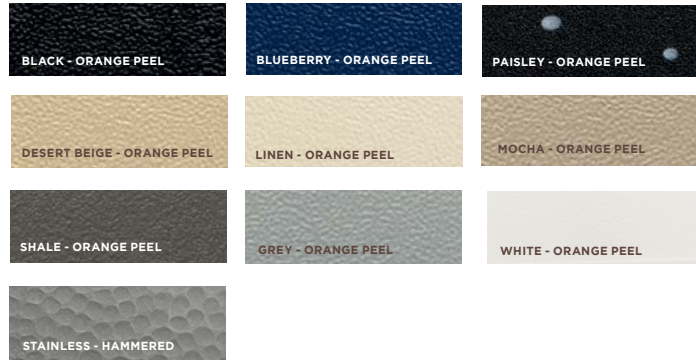

## COLORS TESTED TO MEET ASTM E84, CLASS B

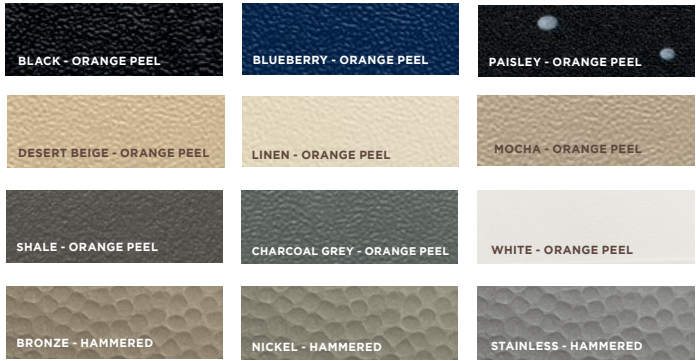

## STANDARD COLOR COLLECTION†

### TRADITIONAL COLOR COLLECTION

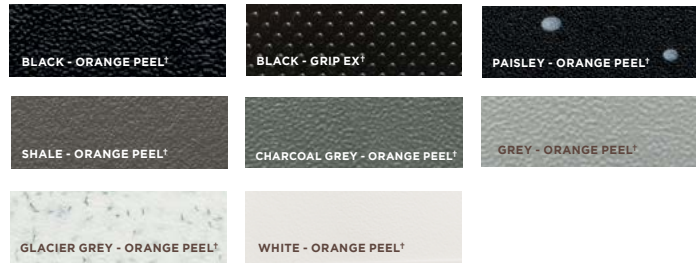

### WARM TONE COLOR COLLECTION

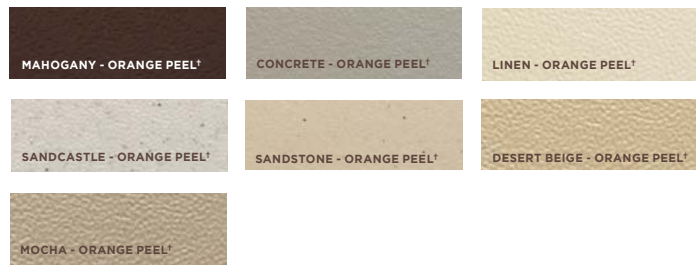

### BOLD COLOR COLLECTION

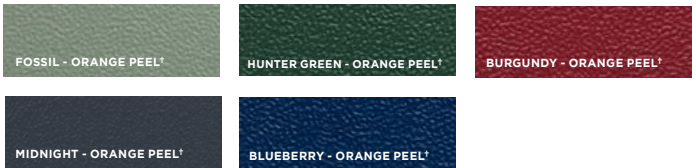

### METALLIC COLOR COLLECTION

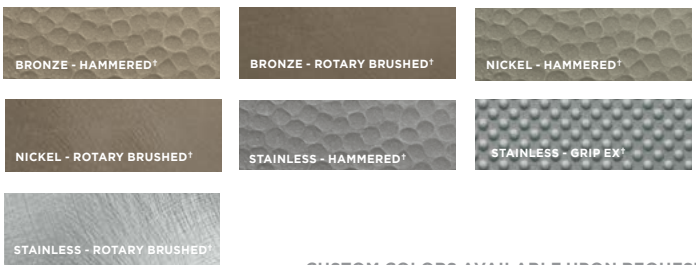

CUSTOM COLORS AVAILABLE UPON REQUEST

Color matching is limited by printing process. Actual samples are available and recommended prior to color selections. \*Minimum order requirements, lead-times & upcharges may all apply.

## DESIGN OPTIONS

### STIRRUP BRACKETS

Aluminum or Stainless Steel

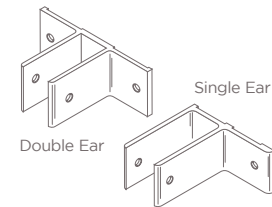

### CONTINUOUS BRACKETS

Double & Single Ear Brackets

Plastic: 41", 54"  
Aluminum: 41", 47", 54", 68", 71", 76"  
Stainless Steel: 41", 54", 71"

U Brackets  
Plastic & Aluminum: 29", 54"  
Stainless Steel: 54", 71"

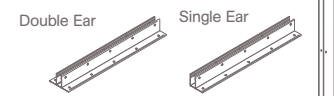

### HINGES

8" Wrap Around

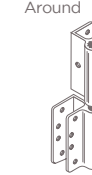

54", 71" Continuous Stainless Steel Helix

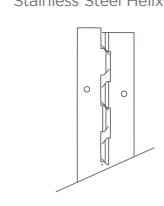

54", 65", 71" Continuous Aluminum



54" Continuous Stainless Steel Spring Loaded

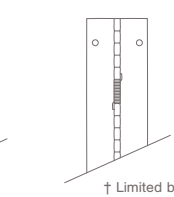

Vault Hinge †

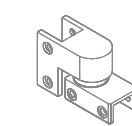

Stealth Integral Hinge †



† Limited by door height and material type.

### HEAD RAIL

Aluminum

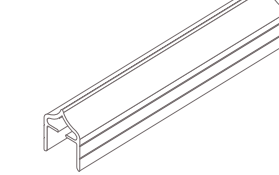

### LATCHES

Aluminum or Stainless Steel

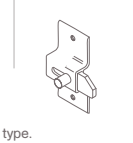

Occupancy Indicator

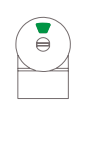

Slider Latch



### STRIKES

6", 54", 65", 71" Aluminum

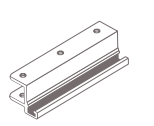

3" Stainless Steel Emergency Access

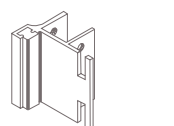

### SHOES

Plastic †

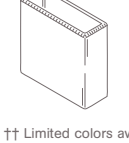

Stainless Steel

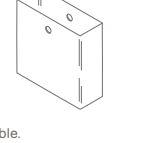

†† Limited colors available.

## HEIGHT OPTIONS



55" Standard

66" High\*

72" Extra High\*

\*Modular panel may be required if stall depth is greater than 55".

## CONFIGURATION OPTIONS



Floor Mounted Overhead Braced



Floor to Ceiling



Ceiling Hung

## SIGNATURE DOOR PANEL ENGRAVING OPTIONS

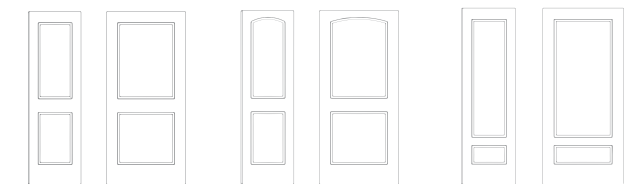

Traditional 2600

Traditional 2800

Modern 3000

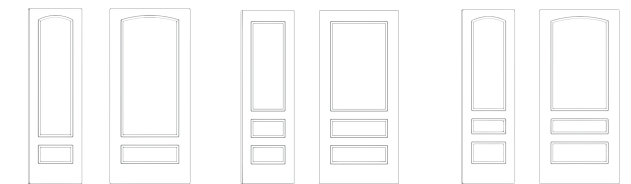

Modern 3200

Modern 3800

Modern 4000



# ADDITIONAL PRODUCT OFFERINGS



## URINAL SCREENS & PANELASTERS

Our urinal screens are designed to withstand use and abuse in public restrooms. Scranton Products solid performance plastic materials clean easily, making them the ideal option. Our privacy and urinal screens are available in four easy to maintain mounting configurations.

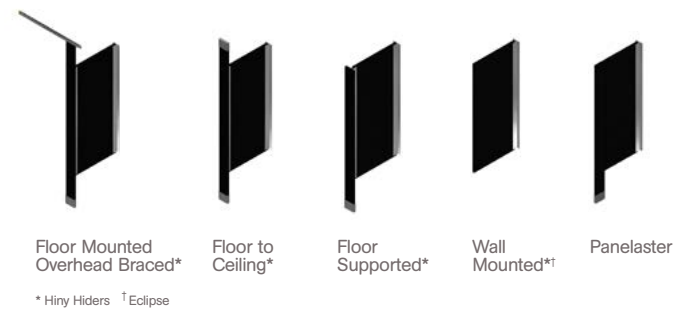

## DRESSING COMPARTMENTS

Our dressing compartments come in a wide variety of colors and textures providing many design options to compliment your décor. Scranton Products performance plastic resists impacts, scratches, corrosion and graffiti which means customers save time, hassle and maintenance costs.

Our dressing compartments feature an integrated head rail designed to accommodate optional curtain hooks and curtains\* eliminating the need for additional curtain rods.

*\*PVC-free shower curtain*

## SHOWER CUBICLES

Scranton Products manufactures shower cubicles that are designed to perform in public shower areas. Solid plastic has no absorption of water and resists mold, mildew and odors. It is easy to clean and resists soap stains, making it the ideal material for your shower application.

Our shower cubicles feature an integrated head rail designed to accommodate optional curtain hooks and curtains\*, eliminating the need for additional curtain rods.

*\*PVC-free shower curtain*



## VANITIES

Scranton Products solid plastic vanity tops combine durability with long-lasting good looks. Offered in a wide variety of colors, our vanities provide an opportunity for you to match your partitions and compliment your overall design.

Our vanity tops have no absorption of water and resist mold, mildew and odors. They are easy to clean and resist soap stains, making them the ideal addition to your bathroom and will provide many years of worry-free performance.



## SHOWER STALL & DRESSING COMPARTMENT COMBO

Our shower stall with dressing compartment combination creates extra privacy for educational and recreational facilities. In addition to all the benefits of our stand-alone shower stalls, solid plastic has no absorption of water and resists mold, mildew, and odors. It also is easy to clean and resists soap stains, making it the ideal material for your shower application.

Floor to ceiling stalls provide occupants with increased privacy and safety, providing ease of mind.

The combo features an integrated headrail designed to accommodate optional curtain hooks and curtains\* eliminating the need for additional curtain rods.

*\*PVC-free shower curtain*

# SUPPORTING A **HEALTHIER** ENVIRONMENT



## EASY ON THE ENVIRONMENT

As an industry leader in responsible recycling, Scranton Products is committed to reducing industrial waste. Scranton Products reclaims all of its scrap and recycles it into production to create new products. Incorporating our solid HDPE

- MADE FROM RECYCLED MATERIALS
- IMPROVED AIR QUALITY
- NO PAINTING MEANS NO VOC EMISSIONS
- CONTAINS 25-100% POST INDUSTRIAL RECYCLED HDPE
- 100% RECYCLABLE
- GREENGUARD GOLD CERTIFIED
- RESISTS MOLD, MILDEW & FUNGUS
- FACTORY RESPONSIBLE RECYCLING

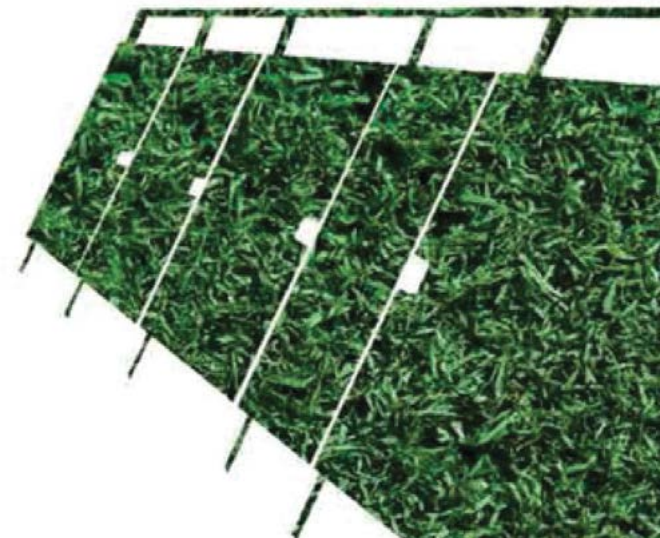

**WE DON'T JUST TALK TOUGH.  
WE BACK IT UP.**

Proudly made in the USA,  
Scranton Products' brands provide  
industry leading protection.  
We are so confident that our plastic  
partitions will stand the test of time  
that they are backed with a full  
25-year warranty covering breakage,  
corrosion and delamination under  
normal conditions.

BATHROOM PARTITIONS  
PRIVACY & HEALTH BARRIERS  
LOCKERS  
CUBBIES  
LOCKER ROOM BENCHES  
SHOWER DIVIDERS  
DRESSING COMPARTMENTS  
URINAL SCREENS  
VANITIES



801 E. Corey Street  
Scranton, PA 18505  
800.445.5148  
info@scrantonproducts.com  
www.scrantonproducts.com

US D887,021 S